

Manufacturer of **Ron StageMaster** | Multi Point Wired and Wireless Load Monitoring

45
Years

OF MEASURING
EXCELLENCE



50t



GSCC - KSC

DCM
LANDSAT

Celebrating **45 years** of measuring excellence



Celebrating 45 years of assuring optimal safety for advanced Load Monitoring and our unique Overload Prevention systems under our renowned trade names of **Ron Crane Scales™** for industry in general and **Ron StageMaster™** geared towards the entertainment industry.

At Eilon Engineering, we pride ourselves on being an independent, family run company. Our greatest asset is our hand-picked team of highly professional and knowledgeable individuals. Through hard work, passion and dedication to our long term vision of unwavering commitment to safety and quality - they continuously improve our technology and maintain our reputation as a world leader in the field of load monitoring and safety.

In 1993 we pioneered the incorporation of wireless communication into our systems for easy and swiftly accessible load cell readings. We keep abreast of this constantly developing technology and bring on board all the most sophisticated advances.

I would like to take this opportunity to express my appreciation to all our loyal users who span the globe - from small companies to Fortune 500 corporations such as NASA, SpaceX, Boeing, GE, Siemens and many others. We look forward to continuing to serve you and your company's needs and implement ever more innovative methods to enhance the safety of all your lifting and rigging activities.

Sincerely,

Eitan Eilon - President



About **Eilon Engineering**

For the last 40 years Eilon Engineering has specialized in the development and manufacture of Ron crane scales, dynamometers and load cells, state-of-the-art products, based on the latest technologies.

During this period, Ron Crane Scales™ became one of the market leaders, internationally known for their safety, high quality, reliability, and unique features like extremely long battery life, compact dimensions, and more.

An uncompromising attitude towards safety and quality has gained Ron Crane Scales™ a global reputation for excellence and has brought thousands of repeat customers, including safety and quality conscious clients like NASA, SpaceX, Boeing, GE, Siemens and many others.

In 2005 Eilon Engineering decided to harness its extensive knowledge in advanced wireless communication as well as its proven load cell technology for the development of an advanced stage load monitoring and overload prevention system. This was the inception of the Ron StageMaster™ system, which shortly after its launch, gained international recognition as well as innovation awards at both LDI and PLASA. Since then, Ron StageMaster™ systems have been chosen by the largest venues, world tours and rigging companies worldwide.



The company's philosophy is based on the following principles:

- The highest possible safety and quality standards
- Technological leadership through ongoing and intensive R&D
- Unique systems with emphasis on usability and comfort
- Quick response time to all service inquiries
- Strong commitment to customer service excellence

All our products are manufactured in accordance with internationally recognized standards under our ISO 9001 quality approved registration.



Why load monitoring on stage is so important

Tons of equipment above people:

Hanging tons of sound, lighting and video equipment above spectators and performers is a serious matter, especially in light of the trend of ever increasing load weight and movement.

Statically Indeterminate Structure Phenomenon:

Each time there are more than two hoists on a truss or more than three hoists in a structure, it becomes statically indeterminate, resulting in an unpredictable load distribution. In most cases this will cause a load imbalance, in which some of the hoists may reach overload while others carry only a small part of the load.

The leveled truss illusion:

The belief that leveling a structure will automatically

create an even load distribution is a dangerous misconception; no connection exists whatsoever between a leveled structure and one with an even load distribution. Because of the unpredictable load distribution, overload situations might happen to the most experienced riggers.

Weather conditions:

This phenomenon may be exacerbated by weather effects such as strong winds or snow build-up on a roof. These conditions might reduce the overload tolerance of the structure which carries the rig.

The solution:

In order to ensure safe shows, real-time load monitoring and overload detection is a must - from installation and throughout the entire show until dismantle.

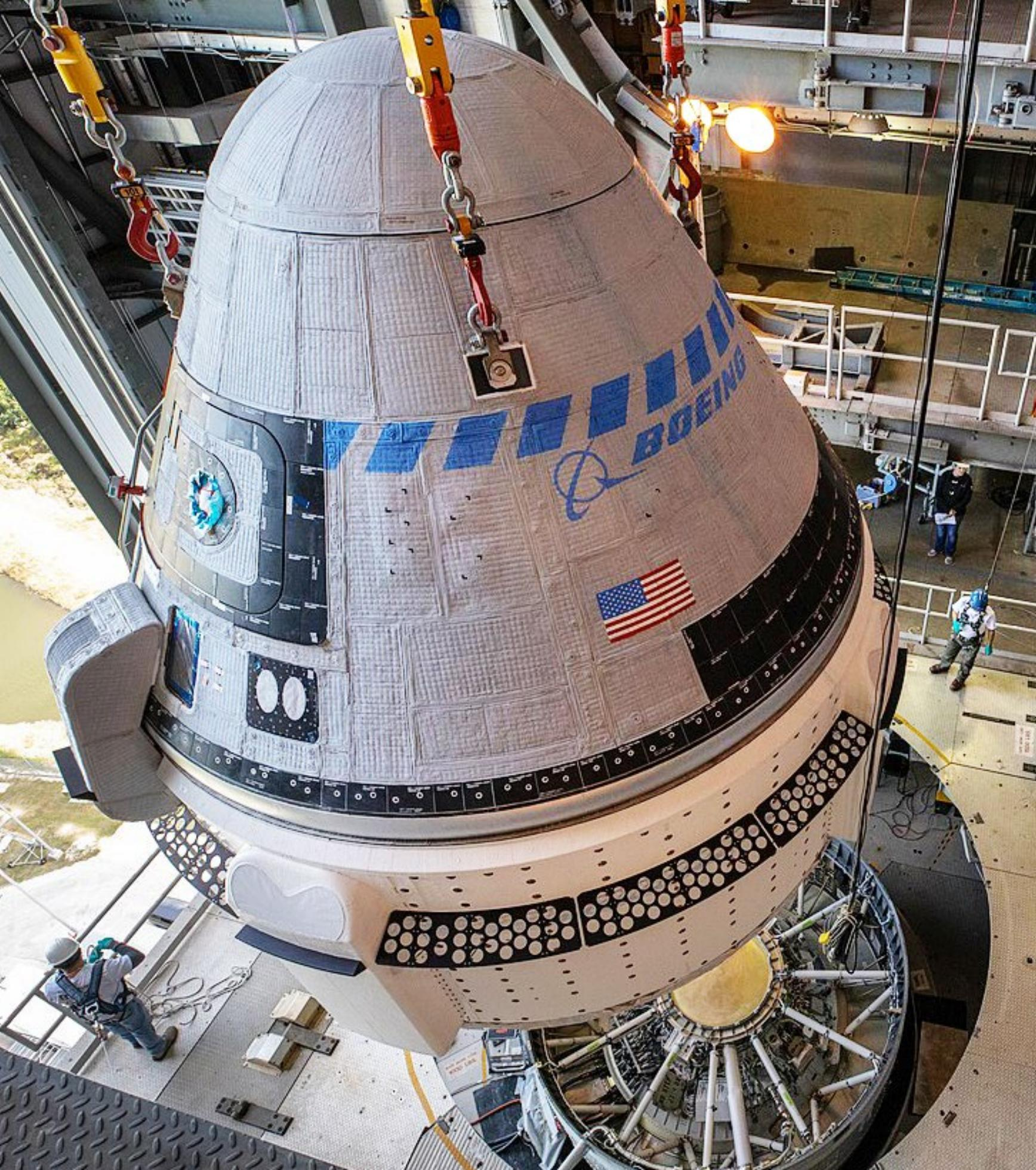



BOEING



The 40's of FOD Prevention

- 1. Cleanroom
- 2. Personnel
- 3. Equipment
- 4. Materials
- 5. Processes

Why Choose Ron StageMaster™?

(some advantages are specific to the wireless models):

SAFETY



- **Continuous load monitoring:** Up to 5000 hour battery life “always on” continuous monitoring. Absolutely no sleep or stand-by modes which are not acceptable from a safety perspective as continuous monitoring is crucial to prevent overloads.
- **0.1% Accuracy:** For early detection of overloads. (Eilon Classic)
- **Fatigue rated load cells:** All Eilon Engineering load cells are fatigue rated, an important feature especially for fixed and long-term installations. The load cell’s ability to withstand successive load cycles for long periods of time without the risk of failure or damage to the steel, affords peace of mind for the user.
- **Market leading 5 Year Warranty:** High quality and reliability.
- **Reliable, independent data flow from each load cell:** Every load cell reports data independently and directly to the Central Receiver, eliminating the danger that damage to a single load cell will affect the rest of the system’s ability to function. This feature is part of both our wired and wireless systems.
- **Wireless Multi-channel transmission** to ensure reliable and continuous load monitoring.
- **Verification mechanism:** An internal safety check ensures that the displayed data is always an exact match to that being transmitted by the load cells.
- **High quality materials:** Including load cells made of aerospace quality, high-strength alloy steel.
- **Perpendicular design:** 90° between shackle holes eliminates bending of the load cell thereby increasing safety and accuracy.
- **Proven wireless and load cell technology since 1976:** More than 30 years of innovative load monitoring for customers including major Fortune 500, aerospace companies and the largest venues and world tours.



FLEXIBILITY



- **Expandability:** Easily expandable by simply adding more load cells to an existing system.
- **Multiple system integration:** Different Ron StageMaster users can combine their load cells into one system when necessary, and one large system can be split into several smaller systems. Both wired and wireless load cells and various capacities and types (Hoist Integrated and Eilon Classic) can be used together.
- **Wide variety of frequencies available:** To suit various environmental conditions.
- **Easy installation:** Completely wireless system, plug and play with no cables required.
- **Wide variety of capacities:** Load cells available in any capacity up to 300t, 5:1, 10:1 and higher safety factors are available.



PERFORMANCE



- **Practically unlimited number of load cells:** Up to 200 load cells per laptop monitoring station and an unlimited number of monitoring stations.
- **Easy and intuitive operation:** Works out of the box, no need for long pre-configuration.
- **Longer battery life:** Up to 5000 hour battery life with a transmission rate of once per second.
- **Environmental:** IP 67/NEMA 4-Weatherproof.
- **Longer transmission range:** Up to 2/3 mile / 1 km or more if required (optional).
- **Heavy duty designs** with shock absorbing mechanisms.
- **Minimal headroom loss:** Short length ensures minimal headroom loss. No need for additional lifting accessories.
- **Works with any controller** to provide automatic E-stop and overload/under-load alarm (visual and audible).
- **Slave-Master option:** For increased range, harsh conditions, and the ability to monitor several halls in one control room.
- **Tablet and smart phone compatibility** allows for portable browsing.
- **Real time load map:** All wireless and wired load cells are displayed on one laptop screen as a real-time load map, overlaid on the stage-plan layout, enabling the rigger to immediately identify the location of an overload and take swift preventative action. In addition, the set points enable immediate motor stop in case of an overload.
- **Multiple groups:** Up to 15 groups, each with its own overload setting and display.
- **Continuous unlimited data logging:** Downloadable data log of months of continuous measurements.
- **Group screen view:** For viewing individual group rigging plans, each with a specific background (included in orders of 50 load cells and up).
- **Real time cellular SMS alert** on overload occurrence.

Ron StageMaster™ 6000 G5 Wireless Eilon Classic - RSM 6000 G5 EC

Designed for quick installation and versatile use.

TECHNICAL SPECIFICATIONS



R.F.: 2.4 GHz range – other ranges available.

R.F. transmission range: Up to 450'/150m in normal operation conditions (outdoors, line of sight). Longer transmission ranges are optional.

Safety Factor: 5:1 and 10:1 standard. Higher safety factors are available.

Fatigue rated: All Eilon Engineering load cells are Fatigue Rated according to ASME BTH-1 and IEC 61508. Fatigue Rated means an unlimited number of load cycles (Provided capacity is not exceeded).

Proof load: 200%.

Accuracy: ± 0.1% of full range.

Capacities: 2t standard capacity with range of capacities from 0.25t to 5t and higher (up to 300t).

Display: Using a laptop or PC, the operator can monitor and control the loads of up to 200 load cells per monitoring station simultaneously, having on one single screen all the relevant information derived from the load cells: Sum (group sum and total structure sum), Max, Tare, Zero, Group (LC), Overload detection, Stage-plan layout, Low battery indication etc.

Functions: Sum, Max, Tare, Zero, Group (LC), Overload detection and alert (visual and audible), Low battery indication, Reports data base, User calibration, Group functions (Sum, Max, Zero, Tare, Overload and customized overload detection), Plan/layout archiving.

Additional Features: Tablet and smart phone compatible.

Units: Selectable: Tons, Kgs, Lbs.

Load Cell Material: Made of high-strength, aerospace quality low alloy steel, polyurethane coated.

Power: 4 x AA 1.5 Volt Alkaline disposable batteries rated 3Ah for each load cell. Batteries will function up to 5000 hours.

Calibration: User calibration. Initial factory calibration, certified and fully traceable to NIST.

Temperature Range: Load cell: -15°F to +175°F / -25°C to +80°C.

Environmental: IP67.

EILON CLASSIC LOAD CELL



Cat no.	Full range	Safety factor	Resolution		Load Cell weight		H1 (max.)		H2 (max.)		B (max.)		Ø D1 (max.)		Ø D2 (min.)		Matching anchor shackle size*
	tons		kgs	lbs	kgs	lbs	mm	inch	mm	inch	mm	inch	mm	inch	mm	inch	
S-005-5	0.5	5	0.5	1	1.1	2.5	123	4.8	92	3.6	16	0.6	31	1.2	21	0.8	5/8", 1/2"
S-01-5	1	5	1	2	1.1	2.5	123	4.8	92	3.6	16	0.6	31	1.2	21	0.8	5/8", 1/2"
S-015-5	1.5	5	2	5	1.1	2.5	137	5.4	100	3.9	19	0.7	37	1.5	21	0.8	5/8", 1/2"
S-02-5	2	5	2	5	1.1	2.5	137	5.4	100	3.9	19	0.7	37	1.5	21	0.8	5/8", 1/2"
S-025-5	2.5	5	2	5	1.1	2.5	137	5.4	100	3.9	19	0.7	37	1.5	21	0.8	5/8", 1/2"
S-03-5	3	5	2	5	1.1	2.5	137	5.4	100	3.9	19	0.7	37	1.5	21	0.8	5/8", 1/2"
S-04-5	4	5	2	5	1.2	2.7	147	5.8	105	4.1	26	1	43	1.7	23	0.9	3/4", 5/8"
S-05-5	5	5	5	10	1.2	2.7	147	5.8	105	4.1	26	1	43	1.7	23	0.9	3/4", 5/8"
S-06-5	6	5	5	10	2	4.5	195	7.7	131	5.2	41	1.6	61	2.4	36	1.4	1 1/4", 1 1/8", 1"
S-08-5	8	5	5	10	2	4.5	195	7.7	131	5.2	41	1.6	61	2.4	36	1.4	1 1/4", 1 1/8", 1"
S-10-5	10	5	5	10	2	4.5	195	7.7	131	5.2	41	1.6	61	2.4	36	1.4	1 1/4", 1 1/8", 1"
S-12-5	12	5	5	10	2	4.5	195	7.7	131	5.2	41	1.6	61	2.4	36	1.4	1 1/4", 1 1/8", 1"
S-005-10	0.5	10	0.5	1	1.1	2.5	123	4.8	92	3.6	16	0.6	31	1.2	21	0.8	5/8", 1/2"
S-01-10	1	10	1	2	1.1	2.5	137	5.4	100	3.9	19	0.7	37	1.5	21	0.8	5/8", 1/2"
S-015-10	1.5	10	2	5	1.1	2.5	137	5.4	100	3.9	19	0.7	37	1.5	21	0.8	5/8", 1/2"
S-02-10	2	10	2	5	1.2	2.7	147	5.8	105	4.1	26	1	43	1.7	23	0.9	3/4", 5/8"
S-025-10	2.5	10	2	5	1.2	2.7	147	5.8	105	4.1	26	1	43	1.7	23	0.9	3/4", 5/8"
S-03-10	3	10	5	10	2	4.5	195	7.7	131	5.2	41	1.6	61	2.4	36	1.4	1 1/4", 1 1/8", 1"
S-04-10	4	10	5	10	2	4.5	195	7.7	131	5.2	41	1.6	61	2.4	36	1.4	1 1/4", 1 1/8", 1"
S-05-10	5	10	5	10	2	4.5	195	7.7	131	5.2	41	1.6	61	2.4	36	1.4	1 1/4", 1 1/8", 1"
S-06-10	6	10	5	10	2	4.5	195	7.7	131	5.2	41	1.6	61	2.4	36	1.4	1 1/4", 1 1/8", 1"

> USE SHACKLES WITH S.W.L. (SAFE WORKING LOAD) EQUAL TO, OR GREATER THAN SYSTEM'S FULL RANGE.

> The company reserves the right to make changes without notice.

OPTIONS



- > Additional channels: 2 standard channels – up to 4 optional channels (recommended for large numbers of load cells and/or harsh conditions).
- > Set point, for integration of RSM system with any controller. Activates E-stop and/or audio visual alarm in case of overloads or underloads.
- > Real time cellular SMS alert on overload occurrence.
- > Single wire option for the wireless receiver.
- > Slave and master CRRs: For increased range, harsh conditions, and the ability to monitor several halls in one control room.
- > Group screen view: For viewing individual group rigging plans, each with a specific background (included in orders of 50 load cells and up).

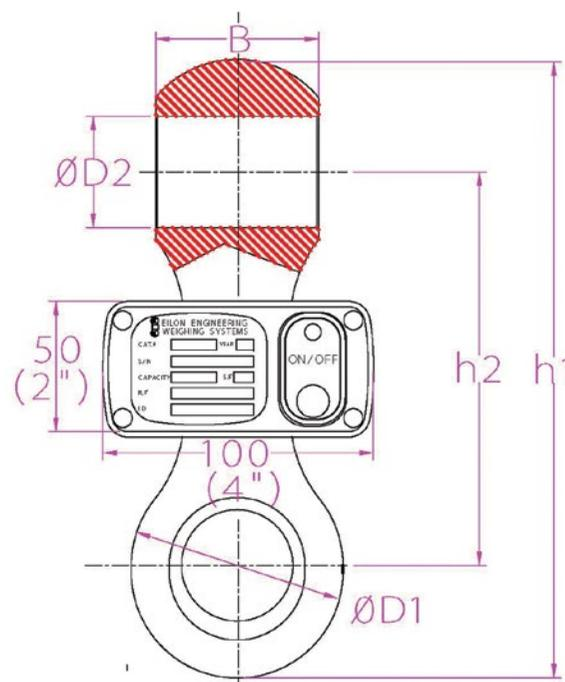

Ron StageMaster™ RSM 6000 G5 Wireless Shackle Pin Load Cells

Extremely low headroom and quick installation

TECHNICAL SPECIFICATIONS



R.F.: 2.4 GHz range – other ranges available.

R.F. transmission range: Up to 450'/150m in normal operation conditions (outdoors, line of sight). Extended transmission range is optional.

Safety Factor: 5:1 and 10:1 standard. Higher safety factors are available.

Fatigue rated: All Eilon Engineering load cells are Fatigue Rated according to ASME BTH-1 and IEC 61508. Fatigue Rated means an unlimited number of load cycles (Provided capacity is not exceeded).

Proof load: 200%.

Accuracy Class: 1%.

Capacities: From 0.25t to 12.5t.

Display: Using a laptop or PC, the operator can monitor and control the loads of up to 200 load cells, per monitoring station, simultaneously, having on one single screen all the relevant information derived from the load cells: Sum (group sum and total structure sum), Max, Tare, Zero, Group (LC), Overload detection,

Stage-plan layout, Low battery indication etc.

Functions: Sum, Max, Tare, Zero, Group (LC), Overload detection and alert (visual and audible), Low battery indication, Reports data base, User calibration, Group functions (Sum, Max, Zero, Tare, Overload and customized overload detection), Plan/layout archiving.

Additional Features: Tablet and smart phone compatible.

Units: Selectable: Tons, Kgs, Lbs.

Load Cell Material: Made of high-strength, PH stainless steel.

Power: 4 x AA 1.5 Volt Alkaline disposable batteries rated 3Ah for each load cell. Batteries will function up to 5000 hours.

Calibration: User calibration. Initial factory calibration, certified and fully traceable to NIST.

Temperature Range: Load cell: -15°F to +175°F / -25°C to +80°C.

Environmental: IP67.



Cat no.	Capacity tons	Safety Factor	Weight		Shackle	A		B		C		D	
			kgs	lbs		mm	inch	mm	inch	mm	inch	mm	inch
SP-005-5	0.5	5:1	1.1	2.4	5/8"	58	2.3	107	4.3	140	5.5	43	1.7
SP-01-5	1	5:1	1.1	2.4	5/8"	58	2.3	107	4.3	140	5.5	43	1.7
SP-015-5	1.5	5:1	1.1	2.4	5/8"	58	2.3	107	4.3	140	5.5	43	1.7
SP-02-5	2	5:1	1.1	2.4	5/8"	58	2.3	107	4.3	140	5.5	43	1.7
SP-025-5	2.5	5:1	1.1	2.4	5/8"	58	2.3	107	4.3	140	5.5	43	1.7
SP-03-5	3	5:1	1.1	2.4	5/8"	58	2.3	107	4.3	140	5.5	43	1.7
SP-04-5	4	5:1	1.1	2.4	5/8"	58	2.3	107	4.3	140	5.5	43	1.7
SP-05-5	5	5:1	1.1	2.4	5/8"	58	2.3	107	4.3	140	5.5	43	1.7
SP-06-5	6	5:1	2.7	6	1"	85	3.3	178	7	186	7.3	68	2.7
SP-08-5	8	5:1	2.7	6	1"	85	3.3	178	7	186	7.3	68	2.7
SP-10-5	10	5:1	2.7	6	1"	85	3.3	178	7	186	7.3	68	2.7
SP-12-5	12	5:1	2.7	6	1"	85	3.3	178	7	186	7.3	68	2.7
SP-005-10	0.5	10:1	1.1	2.4	5/8"	58	2.3	107	4.3	140	5.5	43	1.7
SP-01-10	1	10:1	1.1	2.4	5/8"	58	2.3	107	4.3	140	5.5	43	1.7
SP-015-10	1.5	10:1	1.1	2.4	5/8"	58	2.3	107	4.3	140	5.5	43	1.7
SP-02-10	2	10:1	1.1	2.4	5/8"	58	2.3	107	4.3	140	5.5	43	1.7
SP-025-10	2.5	10:1	1.1	2.4	5/8"	58	2.3	107	4.3	140	5.5	43	1.7
SP-03-10	3	10:1	2.7	6	1"	85	3.3	178	7	186	7.3	68	2.7
SP-04-10	4	10:1	2.7	6	1"	85	3.3	178	7	186	7.3	68	2.7
SP-05-10	5	10:1	2.7	6	1"	85	3.3	178	7	186	7.3	68	2.7
SP-06-10	6	10:1	2.7	6	1"	85	3.3	178	7	186	7.3	68	2.7

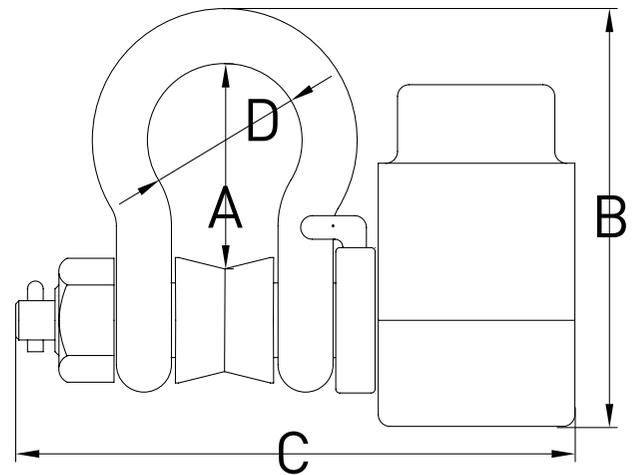

> The company reserves the right to make changes without notice.

OPTIONS



- > Additional channels: 2 standard channels – up to 4 optional channels (recommended for large numbers of load cells and/or harsh conditions).
- > Set point, for integration of RSM system with any controller. Activates E-stop and/or audio visual alarm in case of overloads or underloads.
- > Real time cellular SMS alert on overload occurrence.
- > Single wire option for the wireless receiver.
- > Slave and master CRRs: For increased range, harsh conditions, and the ability to monitor several halls in one control room.
- > Group screen view: For viewing individual group rigging plans, each with a specific background (included in orders of 50 load cells and up).

Ron StageMaster™ 5000 G4 Wired - RSM 5000 G4

Fatigue rated - ideal for permanent or long term installations

TECHNICAL SPECIFICATIONS Ⓟ

Communication: RS-485. The load cells are connected to small junction boxes and the junction boxes are connected to a single main wire descending from the truss to the Central Receiver.

Safety Factor: 5:1 and 10:1 standard. Higher safety factors are available.

Fatigue rated: All Eilon Engineering load cells are Fatigue Rated according to ASME BTH-1 and IEC 61508. Fatigue Rated means an unlimited number of load cycles (Provided capacity is not exceeded).

Proof load: 200%.

Accuracy: ± 0.1% of full range.

Capacities: 2t standard capacity with range of capacities from 0.25t to 5t and higher (up to 300t).

Display: Using a laptop or PC, the operator can monitor and control the loads of up to 200 load cells per monitoring station simultaneously, having on one single screen all the relevant information derived from the load cells: Sum (group sum and total structure sum), Max, Tare, Zero, Group (LC), Overload detection,

Stage-plan layout etc.

Functions: Sum, Max, Tare, Zero, Group (LC), Overload detection and alert (visual and audible), Reports data base, User calibration, Group functions (Sum, Max, Zero, Tare, Overload and customized overload detection), Plan/layout archiving.

Additional features: Tablet and smart phone compatible.

Units: Selectable: Tons, Kgs, Lbs.

Load Cell Material: Made of high-strength, aerospace quality low alloy steel, polyurethane coated.

Power: External power supply provided with the system.

Calibration: User calibration. Initial factory calibration, certified and fully traceable to NIST.

Temperature Range: Load cell: -15°F to +175°F / -25°C to +80°C

Environmental: Weatherproof, Nema 4, IP 65. Higher sealing levels available.

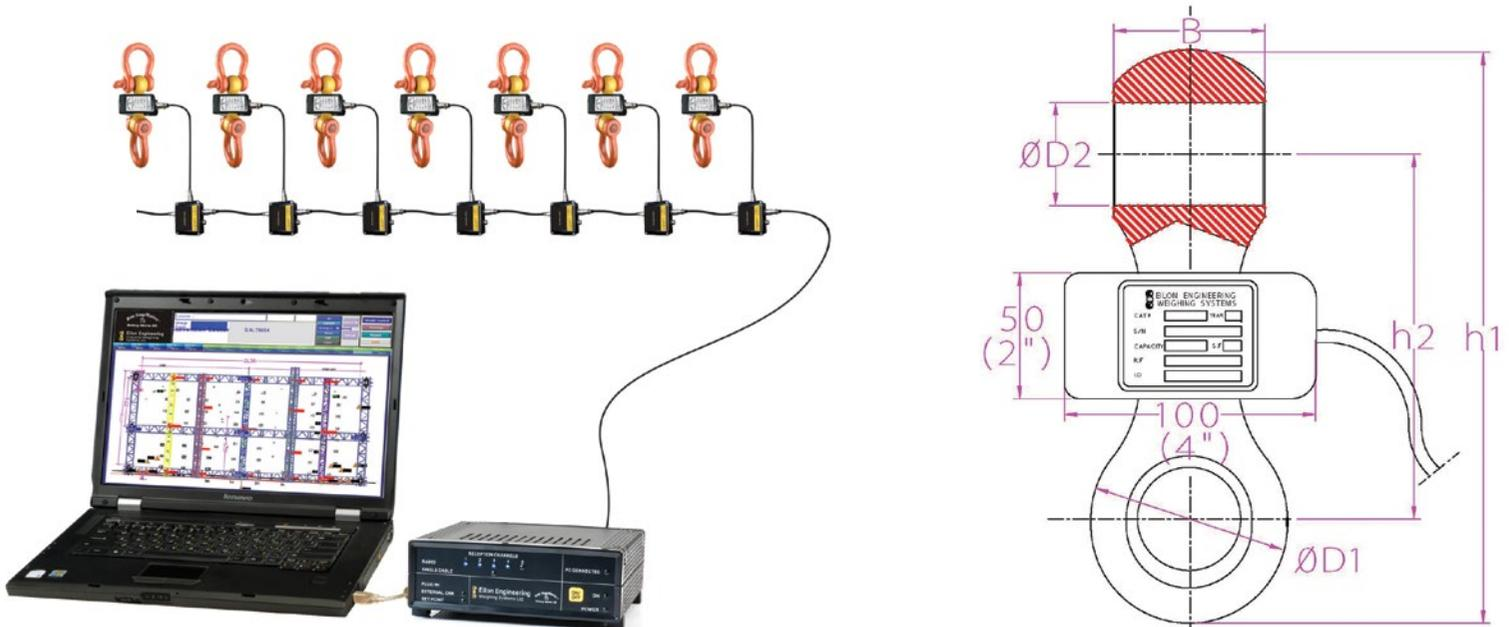

Cat no.	Full range	Safety factor	Resolution		Load Cell weight		H1 (max.)		H2 (max.)		B (max.)		L(max.)		Ø D1 (max.)		Ø D2 (min.)		Matching anchor shackle size*
	tons		kgs	lbs	kgs	lbs	mm	inch	mm	inch	mm	inch	mm	inch	mm	inch	mm	inch	inch
S-0025-5	0.25	5	0.5	1	1.1	2.5	140	5.5	100	4	19	0.75	110	4.4	38	1.5	21	0.82	5/8, 1/2
S-0025-10	0.25	10	0.5	1	1.1	2.5	140	5.5	100	4	19	0.75	110	4.4	38	1.5	21	0.82	5/8, 1/2
S-005-5	0.5	5	0.5	1	1.1	2.5	140	5.5	100	4	19	0.75	110	4.4	38	1.5	21	0.82	5/8, 1/2
S-005-10	0.5	10	0.5	1	1.1	2.5	140	5.5	100	4	19	0.75	110	4.4	38	1.5	21	0.82	5/8, 1/2
S-01-5	1	5	1	2	1.1	2.5	140	5.5	100	4	19	0.75	110	4.4	38	1.5	21	0.82	5/8, 1/2
S-01-10	1	10	1	2	1.1	2.5	140	5.5	100	4	19	0.75	110	4.4	38	1.5	21	0.82	5/8, 1/2
S-015-5	1.5	5	2	5	1.1	2.5	140	5.5	100	4	19	0.75	110	4.4	38	1.5	21	0.82	5/8, 1/2
S-015-10	1.5	10	2	5	1.1	2.5	140	5.5	100	4	19	0.75	110	4.4	38	1.5	21	0.82	5/8, 1/2
S-02-5	2	5	2	5	1.1	2.5	140	5.5	100	4	19	0.75	110	4.4	38	1.5	21	0.82	5/8, 1/2
S-02-10	2	10	2	5	1.2	2.7	150	5.9	105	4.2	26	1	115	4.7	45	1.75	23	0.9	3/4, 5/8
S-025-5	2.5	5	2	5	1.1	2.5	140	5.5	100	4	19	0.75	110	4.4	38	1.5	21	0.82	5/8, 1/2
S-025-10	2.5	10	2	5	1.2	2.7	150	5.9	105	4.2	26	1	115	4.7	45	1.75	23	0.9	3/4, 5/8
S-03-5	3	5	2	5	1.1	2.5	140	5.5	100	4	19	0.75	110	4.4	38	1.5	21	0.82	5/8, 1/2
S-03-10	3	10	5	10	2	4.5	200	7.9	135	5.3	41	1.6	120	4.8	63	2.5	36	1.4	11/4, 11/8, 1
S-04-5	4	5	2	5	1.2	2.7	150	5.9	105	4.2	26	1	115	4.7	45	1.75	23	0.9	3/4, 5/8
S-04-10	4	10	5	10	2	4.5	200	7.9	135	5.3	41	1.6	120	4.8	63	2.5	36	1.4	11/4, 11/8, 1
S-05-5	5	5	5	10	1.2	2.7	150	5.9	105	4.2	26	1	115	4.7	45	1.75	23	0.9	3/4, 5/8
S-05-10	5	10	5	10	2	4.5	200	7.9	135	5.3	41	1.6	120	4.8	63	2.5	36	1.4	11/4, 11/8, 1
S-06-5	6	5	5	10	2	4.5	200	7.9	135	5.3	41	1.6	120	4.8	63	2.5	36	1.4	11/4, 11/8, 1
S-06-10	6	10	5	10	2	4.5	200	7.9	135	5.3	41	1.6	120	4.8	63	2.5	36	1.4	11/4, 11/8, 1

> USE SHACKLES WITH S.W.L. (SAFE WORKING LOAD) EQUAL TO, OR GREATER THAN SYSTEM'S FULL RANGE.

> The company reserves the right to make changes without notice.

OPTIONS



- > Set point, for integration of RSM system with any controller. Activates E-stop and/or audio visual alarm in case of overloads or underloads.
- > Real time cellular SMS alert on overload occurrence.
- > Slave and master CRRs: For increased range, harsh conditions, and the ability to monitor several halls in one control room.
- > Group screen view: For viewing individual group rigging plans, each with a specific background (included in orders of 50 load cells and up).

Receivers

All Types of **Central Radio Receivers (CRRS)**

Receiver type	Photo	Receiver Description	Advantages	Housing
HHI		Hand Held indicator for Small Installations. Capable of displaying measurement from up to 8 individual load cells or the combined total of their loads.	Low cost, entry level indicator for small installations	Hand held ABS 1/2" / 12mm digits
PRR		Portable Radio Receiver. Allows for transmission of measurement data of up to 75 load cells to any smartphone or tablet. Loads can be displayed as a real-time load map, table or bar graph.	Advanced receiver with bluetooth communication for tablets and smartphones. Loads can be displayed as a real-time load map, table or bar graph.	Portable Radio Receiver Tablet / Smartphone
Standard		Standard Radio Receiver for use with laptops. Allows for display of measurement data of up to 100 load cells on a real time load map.	Full featured desktop receiver. For medium sized installations. Real time load map	Desk ABS L 199mm W 223mm H 72mm
Premium		Premium Radio Receiver for use with laptops. Allows for display of measurement data of up to 200 load cells on a real time load map.	Full featured desktop receiver. For massive installations. Real time load map	Desk ABS L 199mm W 223mm H 72mm
DIN 19"		Rack Mountable Radio Receiver for use with laptops. Allows for display of measurement data of up to 200 load cells on a real time load map.	Full featured rack mountable radio receiver. Can be mounted in optional flight case. For massive installations, tours and venues. Real time load map	Rack mountable Metal L 482mm W 200mm H 66mm

* Number of channels determines the maximum number of load cells and signal reliability in harsh environments.

** Slave Radio Receivers can be used to extend range, overcome harsh environments, increase number of load cells and/or allow for monitoring of several halls from central location (with Master/Slave option only)

Max. number of load cells displayed	Standard number of channels	Max. number of channels - optional*	Receiver's battery life (h)	Includes: Carrying case, laptop & software	Options		
					Max. Number of Slaves** (Requires Master/Slave option)	Set point, flight case, SMS	SD memory, Ethernet
Up to 8. The indicator can show each load cell's measurement individually or their combined total	1	1	30	x	x	x	x
Up to 75 load cells	2	2	40	x	x	x	x
Up to 100. Real time load map	2	2	From mains	✓	1	✓	x
Up to 200 load cells per monitoring station and unlimited number of monitoring stations. Real time load map	2	4	From mains	✓	2	✓	✓
Up to 200 load cells per monitoring station and unlimited number of monitoring stations. Real time load map	2	6	From mains	No carrying case - optional flight case	3	✓	✓

Selection of projects & testimonials

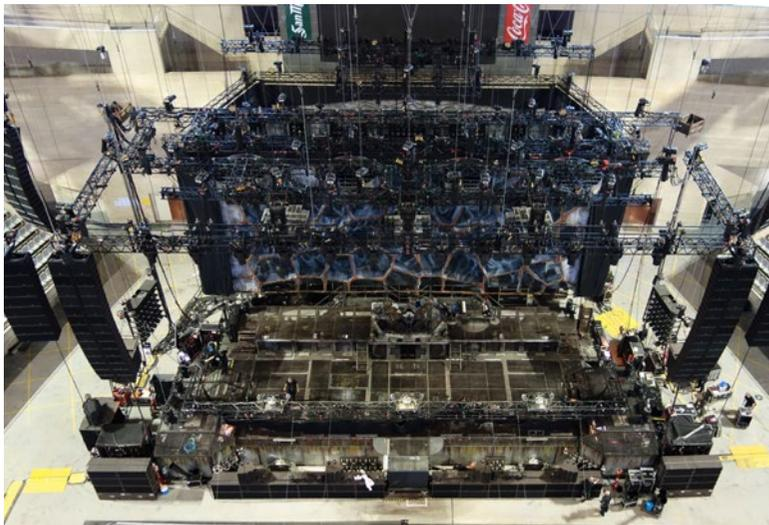

MTV VIDEO MUSIC AWARDS



For the 2013 MTV Video Music Awards, the client elected to re-imagine the familiar Moon Man Logo. The Moon Man was the main element in the staging, and appeared as an impressive sixty foot tall inflatable whose head was also used as a band shell for the main stage. The rigging structure used weighed 26,000 lbs, was a little more than fifty one feet tall, and over forty six feet in diameter at its widest point. In order to achieve this task, Kish Rigging, one of the world's top rigging companies, elected to use twenty-eight individual inverted one ton chain hoists in specific locations with a Ron StageMaster load cell on each hoist. JR Cassidy, head rigger for Kish Rigging, commented "I considered it essential to include Eilon Wireless Load Cells to monitor the loads as they were applied. The dependability and simplicity of the system gave the near-instant feedback which was needed to avoid damaging the building, or the support grid."

RAMMSTEIN 2009-2013



"We've used the RSM product for a long time, it's a type of insurance and at the end of the day gives peace of mind. We are very satisfied not only with the Ron StageMaster load cells we own but even more with the good support and constant development from Eilon Engineering."

Martin Gehring, co-owner at Germany-based and internationally recognized Dart Rigging GmbH who served as head rigger on Rammstein's 2009-2011 "Liebe ist für alle da" tour, as well as the 2011-2013 "Made in Germany" tour, which ended in August 2013, used Ron StageMaster systems in both tours to monitor the loads on the 50t of suspended gear.

ESPLANADE THEATERS



"We have been using the Ron Stage Master 6000 (RSM) wireless load monitoring system here at Esplanade Theatres on the Bay since April 2008. Our system of 16 load cells has been used for the monitoring of loads in most of our venues, indoor and outdoor. The RSM 6000 has become a useful tool that gives us the ability to know what is going on in our rigs, no guessing, or calculating, regardless of the type of production or the rigging methods being used.

Our RSM 6000 has been used in a wide range of applications from monitoring loads in our Roof Truss System, checking the tensions in guy lines, establishing and monitoring loads in human flying systems, determining how heavy "that" set piece is before it is hung and even checking the weights of flight cases before shipping. I have also used the system on several occasions to assist in the designing and testing of complex load sharing systems. The accuracy of the RSM allows you to test on a smaller scale, to be certain of the loads, forces and methods, before moving up to the real thing.

The RSM 6000 gives our riggers easy access to the information they need and the wireless system saves time by not needing to run cables, and finding the wrong connection has been made. You just put the cell in line, on the point you need and RSM does the rest."

Peter Bretherton, Technical Manager – Staging, Esplanade Theatres on the Bay Co Ltd.



CIRQUE DU SOLEIL.

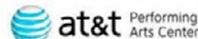

Crane Scales

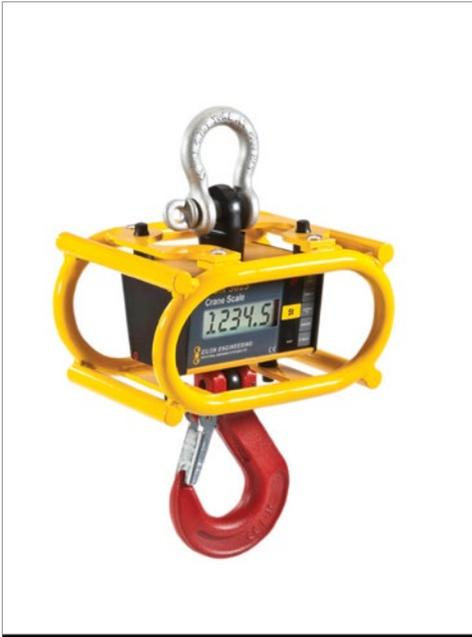

Ron 3025
Crane Scale with 1"/25 mm display.



Ron 3050
Crane Scale with large 2"/50 mm display.

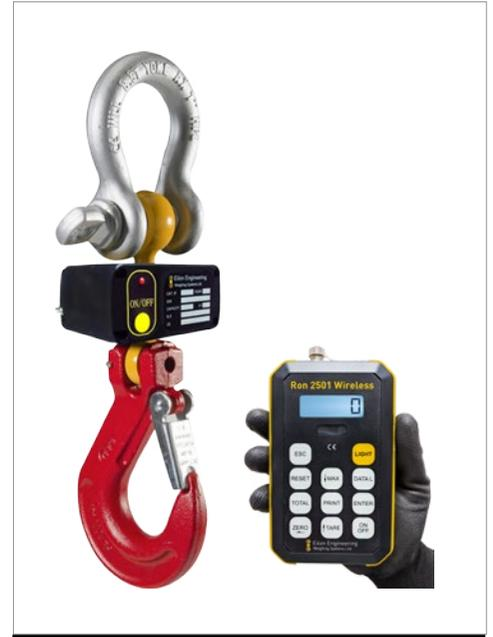

Ron 2501 Hook Type
Crane Scale with wireless remote display.



Ron 2125 Hook Type
Crane Scale with 1"/25 mm with attachable display.



Ron 2150 Hook Type
Crane Scale with 2"/50 mm attachable display.



Ron 2000 Hook Type
Crane Scale with remote display.

Dynamometers



Ron 2000 Shackle Type
Dynamometer with remote display.



Ron 2150 Shackle Type
Dynamometer with 2"/50 mm attachable display.



Ron 2125 Shackle Type
Dynamometer with 1"/25 mm attachable display.

Overload Detectors and Load Cells



Ron 4000
Load Cell with Built in Amplifier

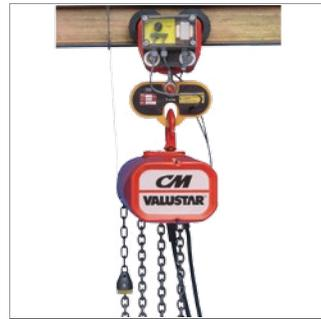

Ron 1000
Hook Type Overload Detector



Ron 1000
Standard Type Overload Detector



Ron 1000
Chain Type Overload Detector

Wireless Dynamometers



Ron 2501 Shackle Type
Dynamometer with wireless remote display.

General / Industrial load monitoring

Bollard pull



Proof load tests



Weighing in foundries

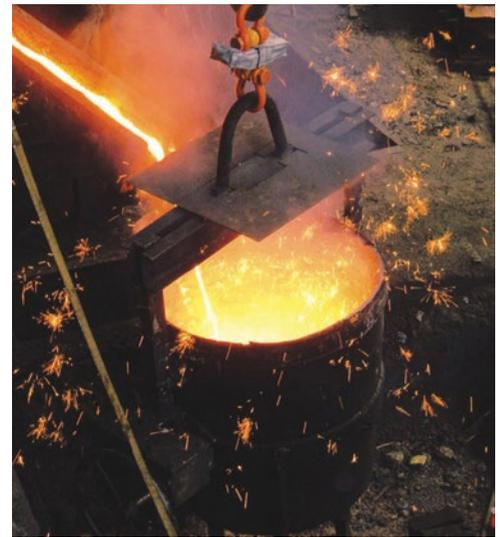

Wind turbine, maintenance, installation and submarine power cable installation



Controlled cable tensioning



Multi point load monitoring



Weighing during manufacturing



NASA



45
Years
OF MEASURING
EXCELLENCE

Eilon Engineering Weighing Systems
Int'l Phone: 1-888-778-8064 (USA & Canada toll free)
E-mail: sales@eilon-engineering.com
www.EilonEngineering.com